



## GWEN COMFORT SLEEPER



- Made in the USA
- Available upholstered and in leather
- Wide selection of fabrics and leathers
- Choice of Walnut, Espresso or Acorn finished leg
- Available with Gel mattress or Tempurpedic mattress at an upcharge
- Also available in sectional and stationary options
- Delivery +/- 8 weeks

*\* Photo: Gwen Queen Comfort Sleeper  
No further discounts applicable and delivery time may be subject to change*

PRODUCT No.	ITEM	WIDTH	DEPTH	HEIGHT	LEATHER				FABRIC			
					GR D/COL	GR F	GR G	GR H	GR I (1)/COM	GR II (2)/CRYPTON	GR III (3)	GR V (5)
112-GWN-SO3-KS	GWEN KING SLEEPER - 3 SEAT	88	39	37	8265	8265	8580	8910	5340	5820	6285	6765
112-GWN-SO3-QP	GWEN QUEEN PLUS SLEEPER - 3 SEAT	78	39	37	7935	7935	8265	8580	5055	5535	6000	6480
112-GWN-SO2-QP	GWEN QUEEN PLUS SLEEPER - 2 SEAT											
112-GWN-SO2-QS	GWEN QUEEN SLEEPER - 2 SEAT	72	39	37	7245	7245	7575	7890	4515	4995	5460	5940
112-GWN-SM2-FS	GWEN FULL SLEEPER - 2 SEAT	66	39	37	6780	6780	7110	7425	4275	4755	5235	5700
112-GWN-CH2-TS	GWEN TWIN SLEEPER - CHAIR AND A HALF	51	39	37	6465	6465	6780	6945	3930	4410	4875	5355
112-GWN-CH2-CS	GWEN COT SLEEPER - CHAIR AND A HALF	42	39	37	5820	5820	6150	6300	3675	4155	4620	5100
112-GWN-DBL-CS	GWEN DOUBLE COT SLEEPER - 2 SEAT	78	39	37	9615	9615	9945	10110	5970	6450	6930	7395
112-GWN-SLA-QP	GWEN LEFT ARM QUEEN PLUS SIZE WITH CHAISE/ STORAGE OTTOMAN	78	66	37	9855	9855	10185	10500	6150	6615	7095	7575
112-GWN-SRA-QP	GWEN RIGHT ARM QUEEN PLUS SIZE WITH CHAISE/ STORAGE OTTOMAN	78	66	37	9855	9855	10185	10500	6150	6615	7095	7575

**Standard Comfort Sleeper®**

**Features:**

- Luxurious sleeping with no springs, no bars and no sagging
- Room to stretch out with true 80 inches of bedroom-length sleeping surface
- Ultimate comfort on five inches of plush, high-density foam
- Complete choice from over 300 leather, Ultrasuede® and fabric options
- Zero wall clearance
- Under sofa dust covers keeps dust and dirt from ever touching the mattress
- Space saving engineering means getting a bigger bed in a smaller room
- Button tufted bench seat cushion
- Loose back & seat cushions
- Single-needle top stitching
- Lifetime warranty on frame
- 10 year mechanism warranty
- Quick-ship delivery

**Mattress Options:**

- Premier
- Gel
- Tempur-Pedic®

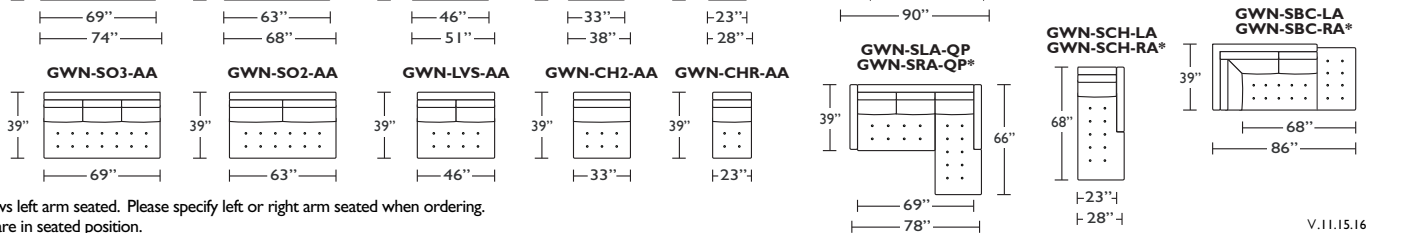
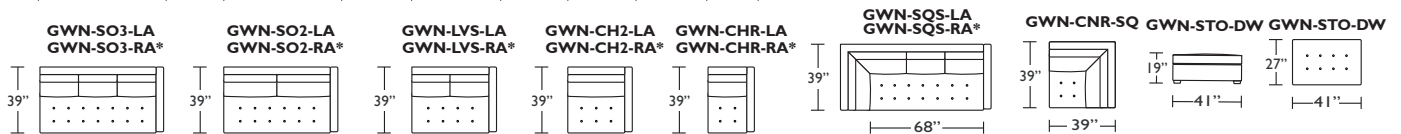
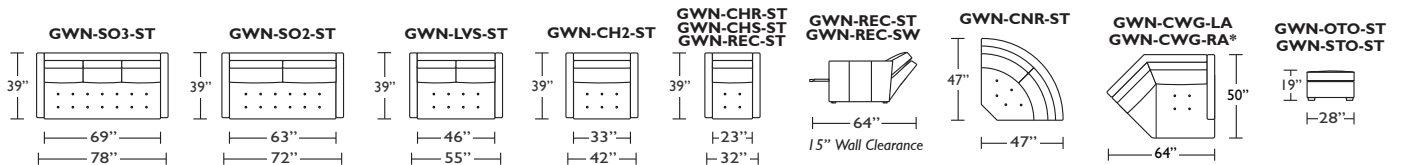
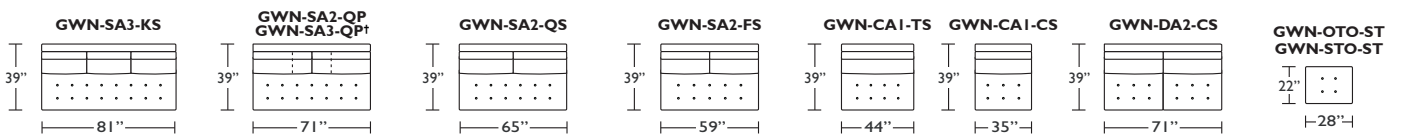
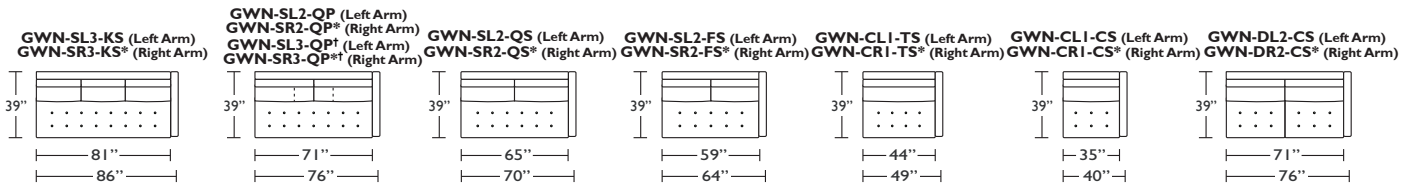
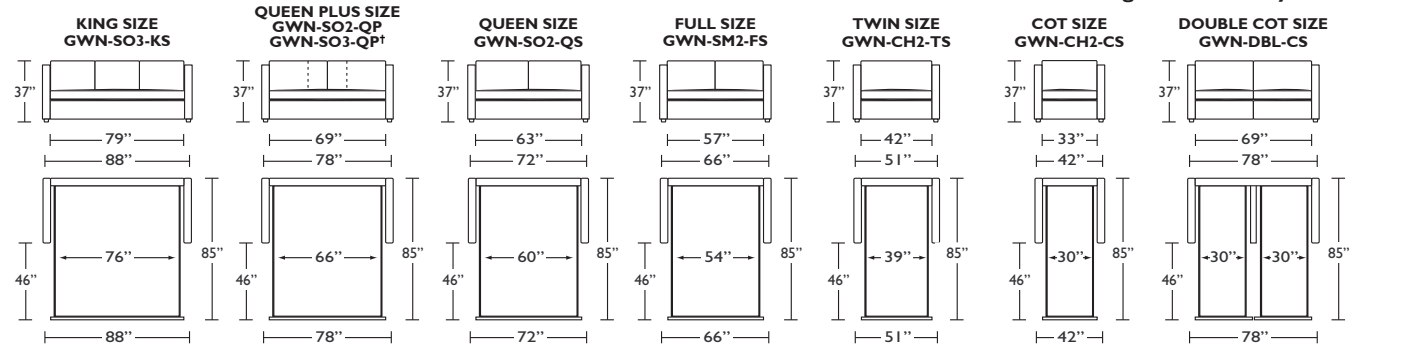

Please use actual leather, fabric and Ultrasuede® swatches when specifying furniture as the colors shown may vary due to the printing process. All dimensions are approximate and subject to change.

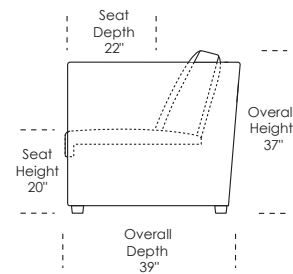

\* Picture shows left arm seated. Please specify left or right arm seated when ordering.  
 All orders are in seated position.  
 † Dotted lines for Queen Plus sizes indicates the number of back cushions.

Tiffany 24/7™ Convertible mechanism, U.S. Patents #6904628, #8893323, #9468303.  
 Additional patents pending.

V.11.15.16  
 Scale:  
 1/8 inch = 1 foot